

SERVICE BULLETIN

No. 300-2-95

Extra considers compliance mandatory

Subject: Inspection of upper longeron at the horizontal stabilizer attachment.

| | MODELS | SERIAL NUMBERS |
|---------------------------|-------------------|----------------|
| Affected Aircraft: | EA 300 | 01 through 62 |
| | EA 300/S | 01 through 29 |
| | EA 300/L | 01 through 71 |
| | | 73 through 77 |
| | | 79 through 83 |
| | | 85 through 89 |
| | 91 and 92 | |
| EA 300/200 | 01 through 31 | |
| | 1032 through 1039 | |

Purpose: Cracks have been reported on EA 300/S, EA 300/L and EA 300/200 airplanes that are frequently operated near or at the design limits. The cracks were found in the upper fuselage longeron and its welds in front of the horizontal stabilizer main spar attachment as well as between the attachment brackets. This Service Bulletin provides instructions for inspection and modifications in this area.

An additional pair of tubes ('V-Tubes') to improve the stiffness of the fuselage cross-section underneath the horizontal stabilizer main spar attachment bracket was introduced for the 300/S with issue D and for the 300/L with issue E of this Service Bulletin. This modification was included in the type design of the 300/S and 300/L from certain advanced serial numbers on in order to offer compatibility with an envisioned enlarged empennage with related higher tail loads. The 300/200 is already equipped with a diagonal tube underneath the horizontal stabilizer main spar attachment bracket. See Appendix B for an overview of the design history.

Approval: The technical content of this document is approved under the authority of DOA Nr. EASA.21J.073.

Compliance time: This Service Bulletin consists of THREE PARTS. Check each serial number of affected aircraft for applicable parts. For some affected aircraft individual repair instructions including additional V-tubes installation have been issued by Extra in the past. If you have complied with related individual repair instruction no additional work is required. In case of doubt contact Extra Flugzeugproduktions- & Vertriebs-GmbH.

EA 300

If you have complied with the previous issue(s) of this Service Bulletin no additional work is required.

PART I First inspection prior to next flight, then recurring as part of the 50h inspection program until PART II of this Service Bulletin has been complied with.

PART II Modification/reinforcement. To be complied with per customer option as alternative means of compliance with PART I. Mandatory when cracks are found during inspection according PART I. In both cases the compliance time from PART I of this Service Bulletin has to be observed. No further action is required.

PART III n.a.

EA 300/S

If you have complied with the previous issue(s) of this Service Bulletin no additional work is required.

PART I First inspection prior to next flight.

PART II Modification/reinforcement within the next 50h time-in-service (TIS).

PART III Compliance must be shown within the next 200h time-in-service (TIS) or two calendar years from the effective date of this Service Bulletin, whichever occurs first. No further action is required.

EA 300/L

a) S/N 01-05

If you have complied with the previous issue(s) of this Service Bulletin no additional work is required.

PART I First inspection prior to next flight. Recurring inspection as part of the 50h inspection program only until PART II of this Service Bulletin has been complied with.

PART II Modification/reinforcement. To be complied with per customer option as alternative means of compliance with PART I. Mandatory when cracks are found during inspection according PART I. In both cases the compliance time from PART I of this Service Bulletin has to be observed.

PART III To be complied with per customer option.

b) S/N 06-44, 80-83, 85-89, 91 and 92

PART I First inspection within the next 10h time-in-service (TIS). Recurring inspection as part of the 50h inspection program only until PART II of this Service Bulletin has been complied with.

PART II Modification/reinforcement. To be complied with per customer option as alternative means of compliance with PART I. Mandatory when cracks are found during inspection according PART I. In both cases the compliance time from PART I of this Service Bulletin has to be observed.

PART III To be complied with per customer option.

c) S/N 45-63, 65-71, 73-77 and 79

PART I First inspection within the next 10h time-in-service (TIS).

PART II Modification/reinforcement within the next 50h time-in-service (TIS).

PART III Compliance must be shown within the next 200h time-in-service (TIS) or two calendar years, whichever occurs first. No further action is required.

d) S/N 64

PART I n.a.

PART II n.a.

PART III Compliance must be shown within the next 200h time-in-service (TIS) or two calendar years, whichever occurs first. No further action is required.

EA 300/200

- PART I** First inspection within the next 10h time-in-service (TIS). Recurring inspection as part of the 50h inspection program only until PART II of this Service Bulletin has been complied with.
- PART II** Modification/reinforcement. To be complied with per customer option as alternative means of compliance with PART I. Mandatory when cracks are found during inspection according PART I. In both cases the compliance time from PART I of this Service Bulletin has to be observed. No further action is required.
- PART III** n.a.

Part I Visual Inspection

Note: Alterations or repair of the aircraft must be accomplished by licensed personnel only.

A repetitive inspection is required at given compliance time.

Instructions:

- Remove tail fairing, rudder, vertical stabilizer, elevator, and horizontal stabilizer (see Chapter 27 and 55 of the Service Manual).
- Remove fabric from fuselage upper longeron in areas A, B and C as shown in Figure 1.
- Visually inspect these areas for potential cracks, particularly at welds.
- In case of doubt remove paint and use a dye check penetrant.
- If cracks are found proceed with the instructions of Part II.
- In case no cracks are found repaint tubing as required and reglue fabric. Reassemble the empennage according Chapters 27 and 55 of the Service Manual.
- Make appropriate logbook entry of compliance with the repetitive inspection according PART I of this Service Bulletin.

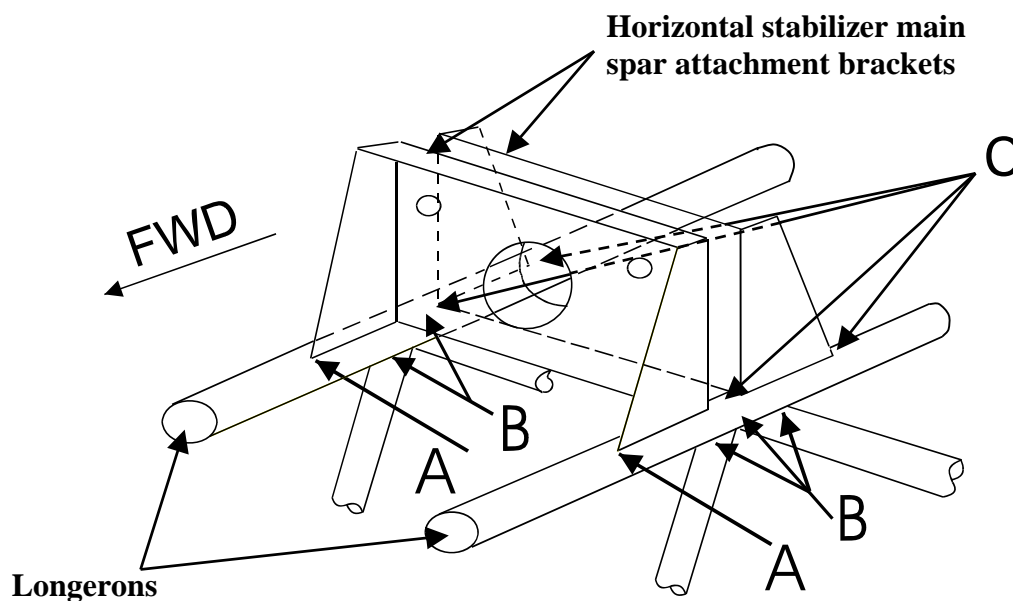

Figure 1: Possible crack locations in typical horizontal stabilizer attachments area.

Part II **Retrofit, local reinforcement at the upper longeron in the area of the horizontal stabilizer main spar attachment.**

Note: Alterations or repair of the aircraft must be accomplished by licensed personnel only. Refer to AC 43.13-1B and Chapter 51-70-05 “Structural Repair of Steel Components” of the Service Manual. TIG welding is required, use appropriate welding rod.

Instructions:

- Remove tail fairing, rudder, vertical stabilizer, elevator and horizontal stabilizer (see Chapter 27 and 55 of the Service Manual).
- Remove elevator control inspection window.
- Disconnect battery ground wire and engine ground wire to firewall.
- Remove fabric and paint from fuselage tubing in areas A, B and C, where the welding will be done later on.
- Install two bushings between the two stabilizer attachment brackets to ensure that the distance between these parts is not affected by welding shrinkage. Use bushings of the same length as used in the horizontal stabilizer spar.
- Weld any crack in areas A, B and C. Cracks in the longerons have to be repaired with sleeves (split tubes) according Figure 2, additionally.
- Prepare parts according applicable kit (see material allowance) and Figure 3 for welding. When split tubes are installed the contours of the reinforcement steel patch plate and the related gussets have to be adjusted slightly to match their surrounding structure.
- Weld parts in place according Figure 3.
- Remove bushings and check for welding shrinkage.
- Reinstall horizontal and vertical stabilizer and check proper alignment of tail surfaces with respect to the wing. Remove stabilizers again.
- Refinish fuselage paint coating, see Chapter 57-70-07 of the Service Manual for details.
- Apply anti-corrosion wax to the related welds.
- Reattach the fabric using standard fabric glue. Follow procedures as given in the Ceconite® 102 manual. If necessary refinish the fabric.
- Reconnect battery ground wire as well as engine ground wire to the firewall.
- Reassemble the aircraft.

- Weigh the aircraft and calculate center of gravity according Chapter 08-10-00 of the Service Manual.
- Make appropriate logbook entry of compliance with PART I and PART II of this Service Bulletin.

Materials allowance:

The material required for the retrofit needs to be ordered from EXTRA Flugzeugproduktions- & Vertriebs-GmbH. Please specify aircraft model, serial number and information of damage found to obtain the appropriate reinforcement kit free of charge (valid only when complying with this Service Bulletin).

Kit No.: SB295E2-1

Eligible for: EA 300 S/N 1-62
EA 300/S S/N 1-29
EA 300/L S/N 1-44, 80-83, 85-89, 91 and 92

Parts: Split tube Ø20x1mm EA-83921.5 1 EA

Kit No.: SB295F2-2

Eligible for: EA 300/L S/N 45-63, 65-71, 73-77 and 79
EA 300/200 S/N 01-31 and 1032-1039

Parts: Split tube Ø1"x0.058" EA-86921.305 1 EA

Kit No.: SB295E2-3

Eligible for: EA 300 S/N 1-62

Parts: Reinforcement steel patch plate EA-24102.23-03 2 EA
Gusset FWD LH EA-84921.4-01 1 EA
Gusset FWD RH EA-84921.4-02 1 EA

Kit No.: SB295E2-4

Eligible for: EA 300/S S/N 1-29

Parts: Reinforcement steel patch plate EA-24102.23-03 2 EA
Gusset FWD LH EA-84921.4-01 1 EA
Gusset FWD RH EA-84921.4-02 1 EA
Gusset AFT LH EA-84921.4-03 1 EA
Gusset AFT RH EA-84921.4-04 1 EA

Kit No.: SB295E2-5

Eligible for: EA 300/L S/N 1-5

| | | | |
|--------|---------------------------------|----------------|------|
| Parts: | Reinforcement steel patch plate | EA-26102.23-03 | 2 EA |
| | Gusset FWD LH | EA-84921.4-01 | 1 EA |
| | Gusset FWD RH | EA-84921.4-02 | 1 EA |

Kit No.: SB295E2-6

Eligible for: EA 300/L S/N 45-63, 65-71, 73-77 and 79

| | | | |
|--------|---------------------------------|-----------------|------|
| Parts: | Reinforcement steel patch plate | EA-26102.323-03 | 2 EA |
| | Gusset LH | EA-86921.304-01 | 2 EA |
| | Gusset RH | EA-86921.304-02 | 2 EA |

Kit No.: SB295E2-7

Eligible for: EA 300/L S/N 6-44, 80-83, 85-89, 91 and 92

| | | | |
|--------|---------------------------------|----------------|------|
| Parts: | Reinforcement steel patch plate | EA-26102.23-03 | 2 EA |
| | Gusset FWD LH | EA-84921.4-01 | 2 EA |
| | Gusset FWD RH | EA-84921.4-02 | 2 EA |

Kit No.: SB295F2-8

Eligible for: EA 300/200 S/N 01-31 and 1032-1039

| | | | |
|--------|------------------------------------|-----------------|------|
| Parts: | Reinforcement steel patch plate LH | EA-27102.323-03 | 1 EA |
| | Reinforcement steel patch plate RH | EA-27102.323-04 | 1 EA |
| | Gusset FWD LH | EA-86921.304-01 | 2 EA |
| | Gusset FWD RH | EA-86921.304-02 | 2 EA |

Please note:

For aircraft in warranty only, 35 manhours is the maximum time to be allowed for the inspection and modification work, per aircraft. Extra Flugzeugproduktions- und Vertriebs-GmbH will only pay for the hours it actually takes an Authorized Service Center (in Europe: Extra Flugzeugproduktions- & Vertriebs-GmbH) to perform the task, up to but not exceeding the “hours” listed. Please reimburse for hourly rates.

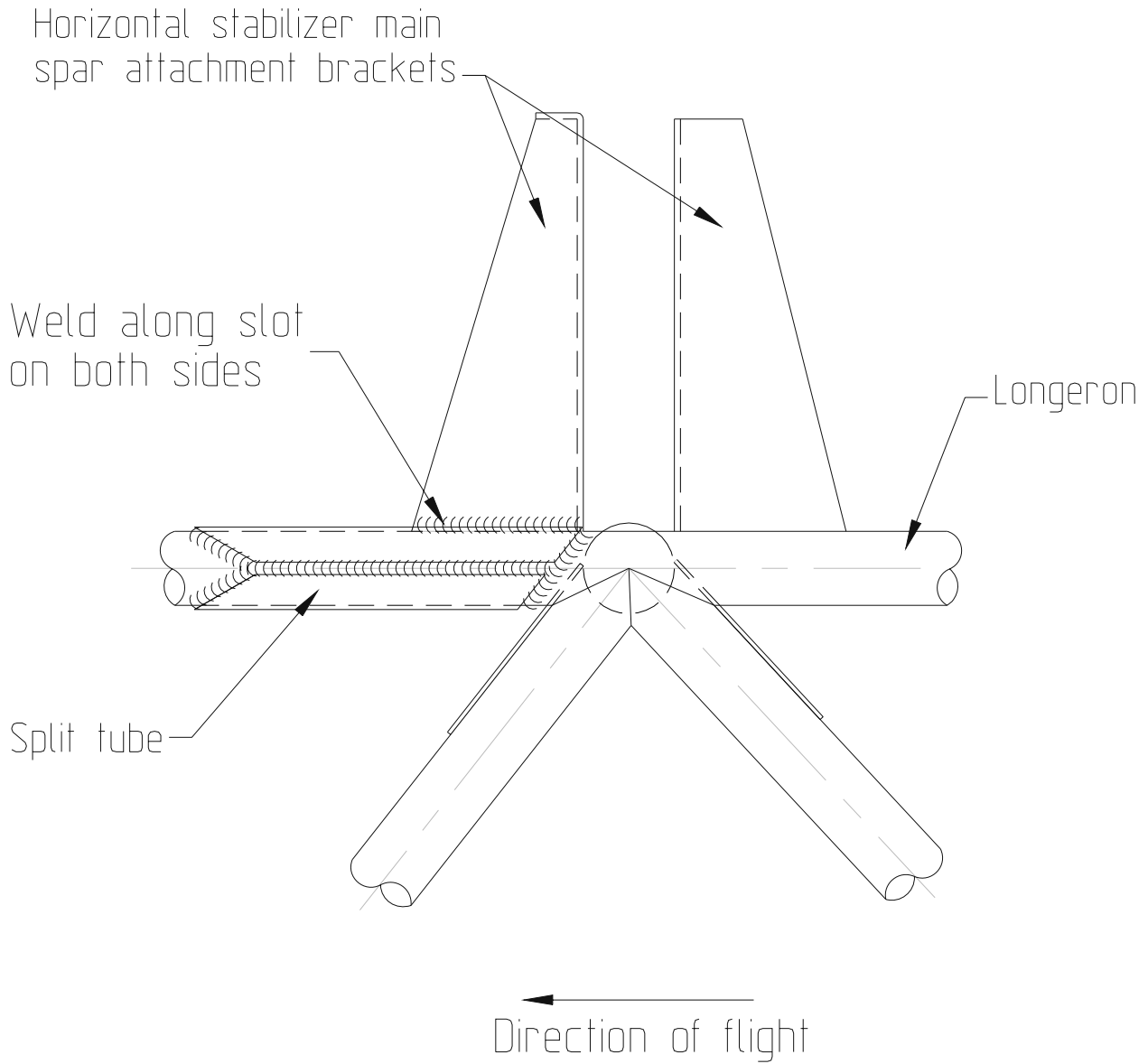

Figure 2: Typical installation of split tubes to repair crack in longeron.

Horizontal stabilizer main
spar attachment brackets

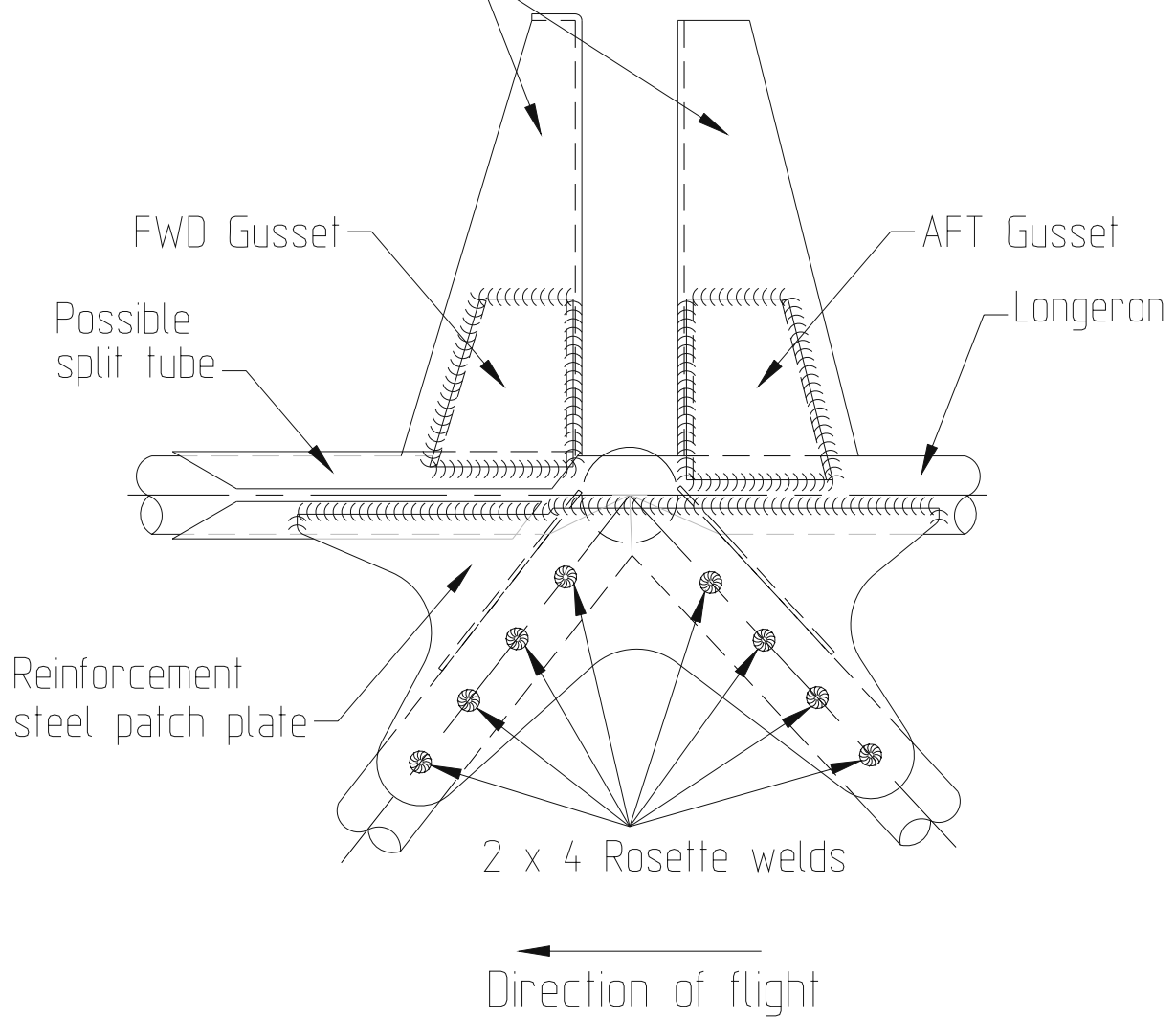

Figure 3: Typical installation of reinforcements in area around horizontal stabilizer main spar attachment brackets (view on left side).

Part III Retrofit of V-tubes to reinforce fuselage frame underneath the horizontal stabilizer main spar attachment bracket.

Note: Alterations or repair of the aircraft must be accomplished by licensed personnel only. Refer to AC 43.13-1B and Chapter 51-70-05 “Structural Repair of Steel Components” of the Service Manual. TIG welding is required, use appropriate welding rod.

The additional V inserted into the fuselage frame underneath the horizontal stabilizer main spar attachment bracket serves the same function as a diagonal, but without interference with the elevator push-pull control. The higher stiffness of the frame against in-plane deformation minimizes local stress concentrations adjacent to the stabilizer attachment bracket reinforcements when the structure is experiencing elastic deformation under flight loads. This modification was included in the type design of the 300/S and 300/L from certain advanced serial numbers on in order to offer compatibility with an envisioned enlarged empennage with related higher tail loads.

Instructions:

Table 2: Applicable Figures

| Model | S/N | Material | Applicable Figures | | | | |
|-------|---------------------------|------------|--------------------|---|---|---|---|
| | | | 4 | 5 | 6 | 7 | 8 |
| 300/S | 1-29 | 1.7734.4 | x | x | | | |
| 300/L | 45-71, 73-77, 79 | AISI 4130n | | | x | x | |
| 300/L | 1-44, 80-83, 85-89, 91-92 | 1.7734.4 | | | x | | x |

- Remove tail fairing, rudder, vertical stabilizer, elevator and horizontal stabilizer (see Chapter 27 and 55 of the Service Manual).
- Remove elevator control inspection window.
- Disconnect battery ground wire and engine ground wire to firewall.
- Remove fabric and paint from fuselage tubing to allow access to the welds later on. Be sure to remove all paint where welding takes place later on.
- Remove the two existing gussets underneath the horizontal stabilizer main spar attachment bracket that would interfere with the V-tubes. Take care not to damage the basic structure.
- Install two bushings between the two stabilizer attachment brackets to ensure that the distance between these parts is not affected by welding shrinkage. Use bushings of the same length as used in the stabilizer spar.
- Make sure the V-tubes match the existing structure according to the applicable Figures (see Table 2).

- For the protection of the tube interior fill a small amount of corrosion preventive compound like ACF-50 or equivalent into each of the V-tubes.
- Weld V-tubes in place and check proper fit of gussets according to the applicable Figures (see Table 2) and weld them in place.
- Remove bushings and check distance between the two attachment brackets to match the length of the respective bushings in the horizontal stabilizer spar within 1mm.
- Reinstall horizontal and vertical stabilizer and check proper alignment of tail surfaces with respect to the wing. Remove stabilizers again.
- Refinish fuselage paint coating, see Chapter 57-70-07 of the Service Manual for details.
- Apply anti-corrosion wax to the related welds.
- Reattach the fabric using standard fabric glue. Follow procedures as given in the Ceconite® 102 manual. If necessary refinish the fabric.
- Reconnect battery ground wire as well as engine ground wire to the firewall.
- Reassemble the aircraft.
- Weigh the aircraft and calculate center of gravity according Chapter 08-10-00 of the Service Manual.
- Make appropriate logbook entry of compliance with PART III of this Service Bulletin.

Materials allowance:

The material required for the retrofit needs to be ordered from EXTRA Flugzeugproduktions- & Vertriebs-GmbH. Please specify aircraft model and serial number to obtain the appropriate reinforcement kit free of charge (valid only when complying with this Service Bulletin).

Kit No.: SB295E3-1

Eligible for: EA 300/S S/N 1-29

| | | | |
|--------|------------------------------|-----------------|------|
| Parts: | V-tube RH (18x1mm, 1.7734.4) | EA-24101.0 #122 | 1 EA |
| | V-tube LH (18x1mm, 1.7734.4) | EA-24101.0 #123 | 1 EA |
| | Gusset LH | EA-24102.24-01 | 1 EA |
| | Gusset RH | EA-24102.24-02 | 1 EA |

Kit No.: SB295E3-2

Eligible for: EA 300/L S/N 45-71, 73-77 and 79

| | | | |
|--------|--------------------------------------|-------------------|------|
| Parts: | V-tube RH (15.88x0.89mm, AISI 4130n) | EA-26101.300 #151 | 1 EA |
| | V-tube LH (15.88x0.89mm, AISI 4130n) | EA-26101.300 #152 | 1 EA |
| | Gusset | EA-26102.324 | 2 EA |

Kit No.: SB295E3-3

Eligible for: EA 300/L S/N 1-44, 80-83, 85-89, 91 and 92

| | | | |
|--------|------------------------------|-----------------|------|
| Parts: | V-tube RH (18x1mm, 1.7734.4) | EA-26101.0 #132 | 1 EA |
| | V-tube LH (18x1mm, 1.7734.4) | EA-26101.0 #133 | 1 EA |
| | Gusset | EA-26102.24 | 2 EA |

Please note:

All affected models were manufactured by the predecessor company Extra Flugzeugbau GmbH. They are not under an Extra Flugzeugproduktions- & Vertriebs-GmbH warranty program.

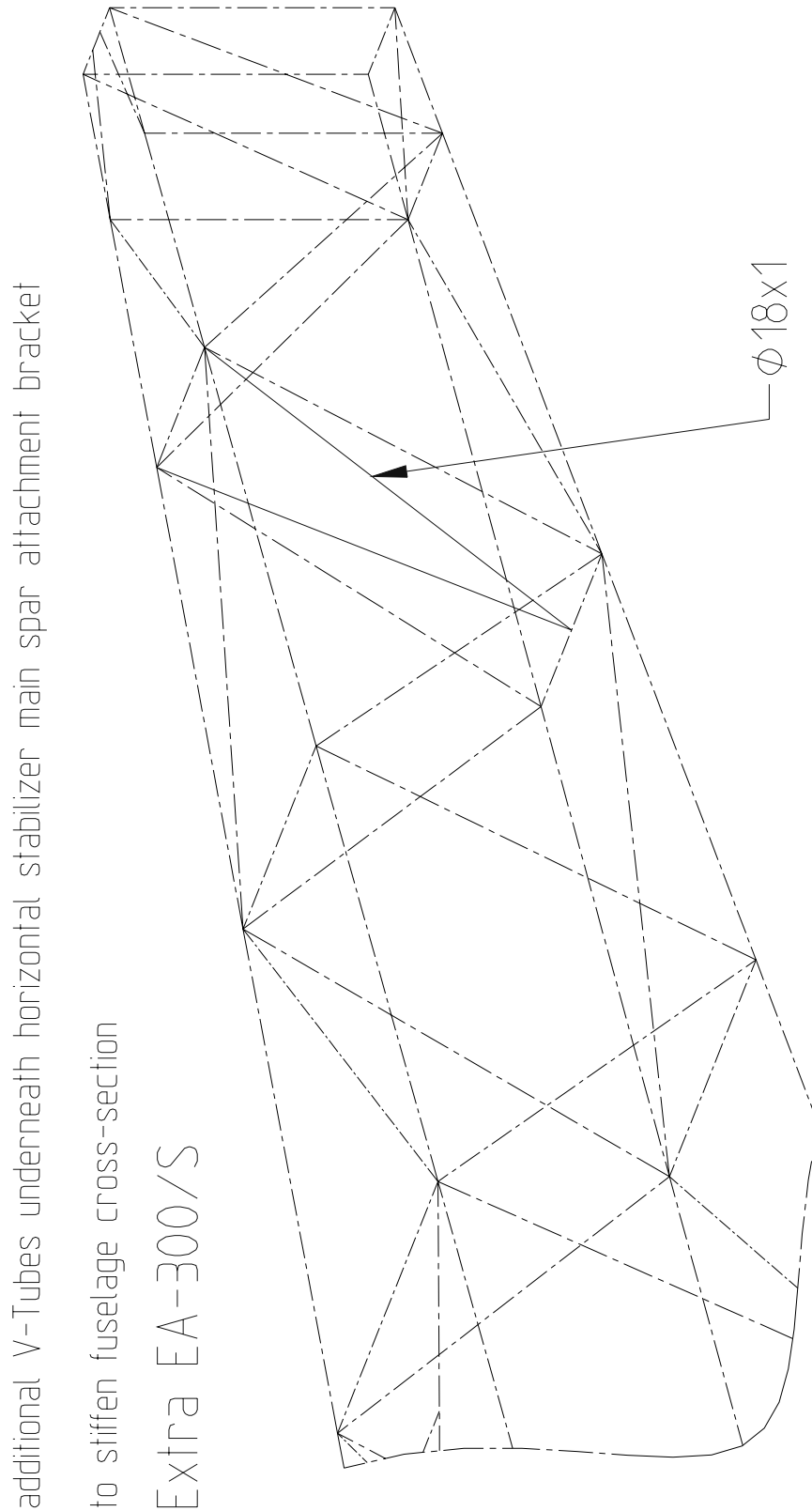

Figure 4: Additional V-tubes in EA 300/S fuselage steel tube frame.

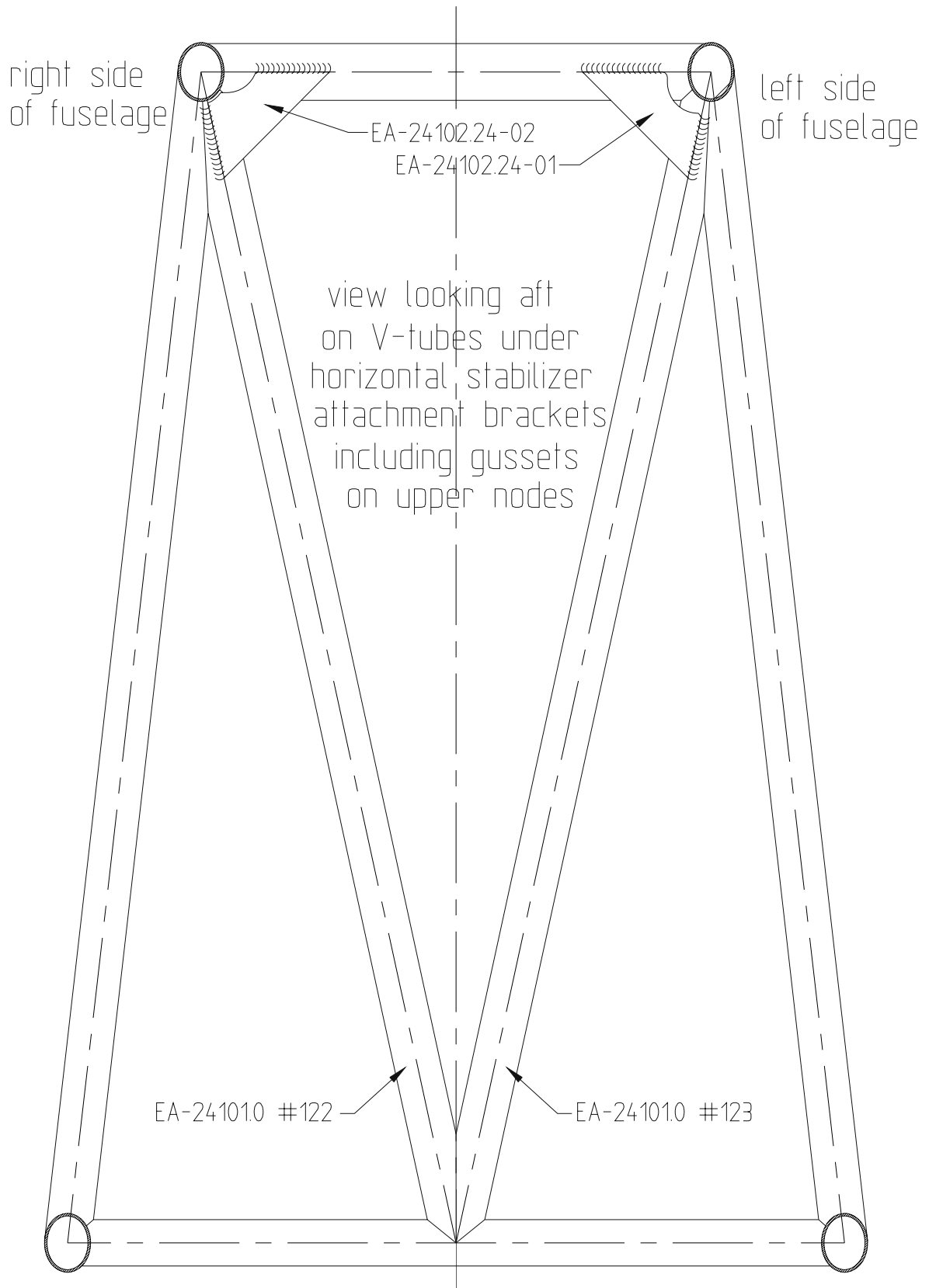

Figure 5: V-tubes and gussets for EA 300/S (Kit No. SB295E3-1).

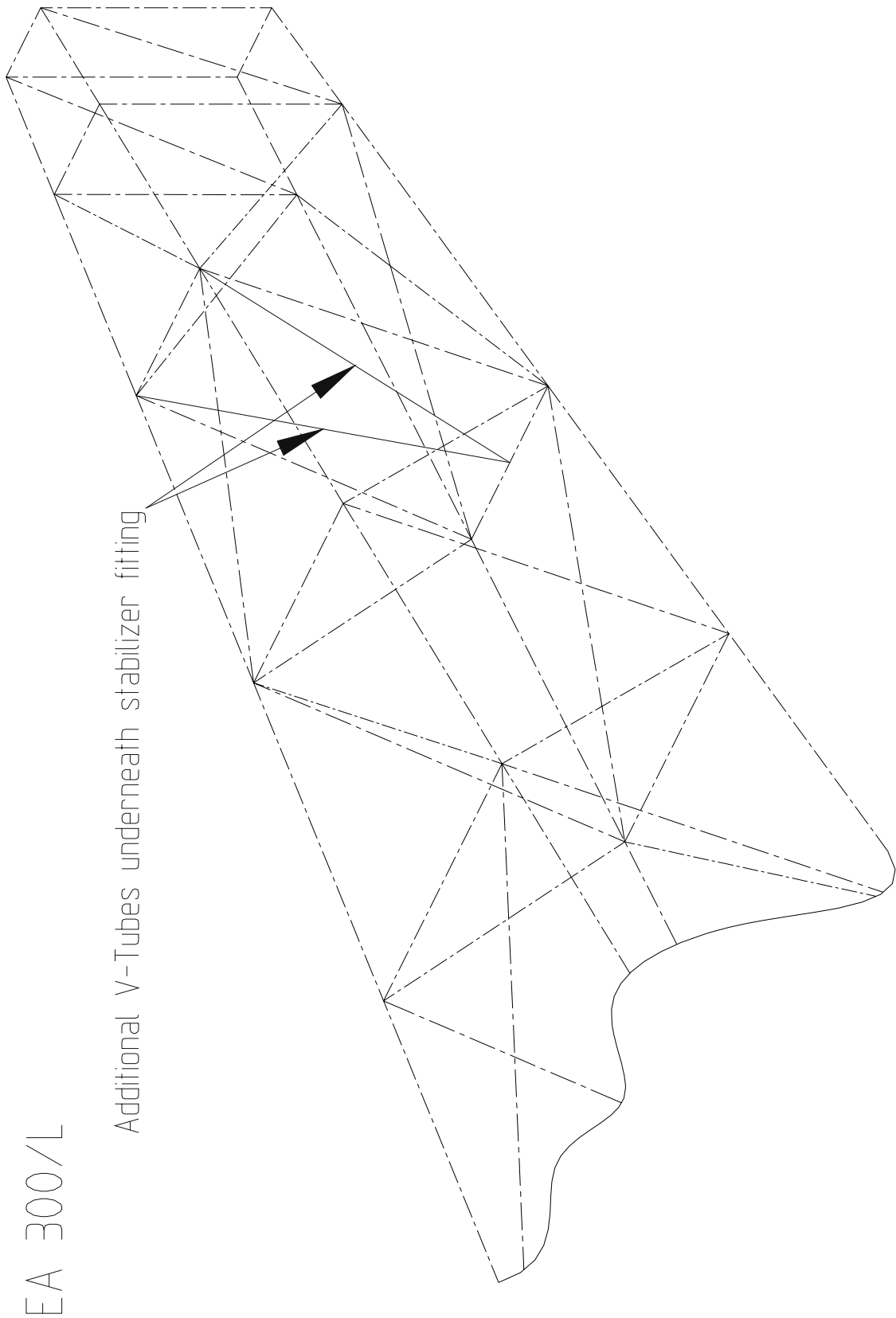

Figure 6: Additional V-tubes in EA 300/L fuselage steel tube frame.

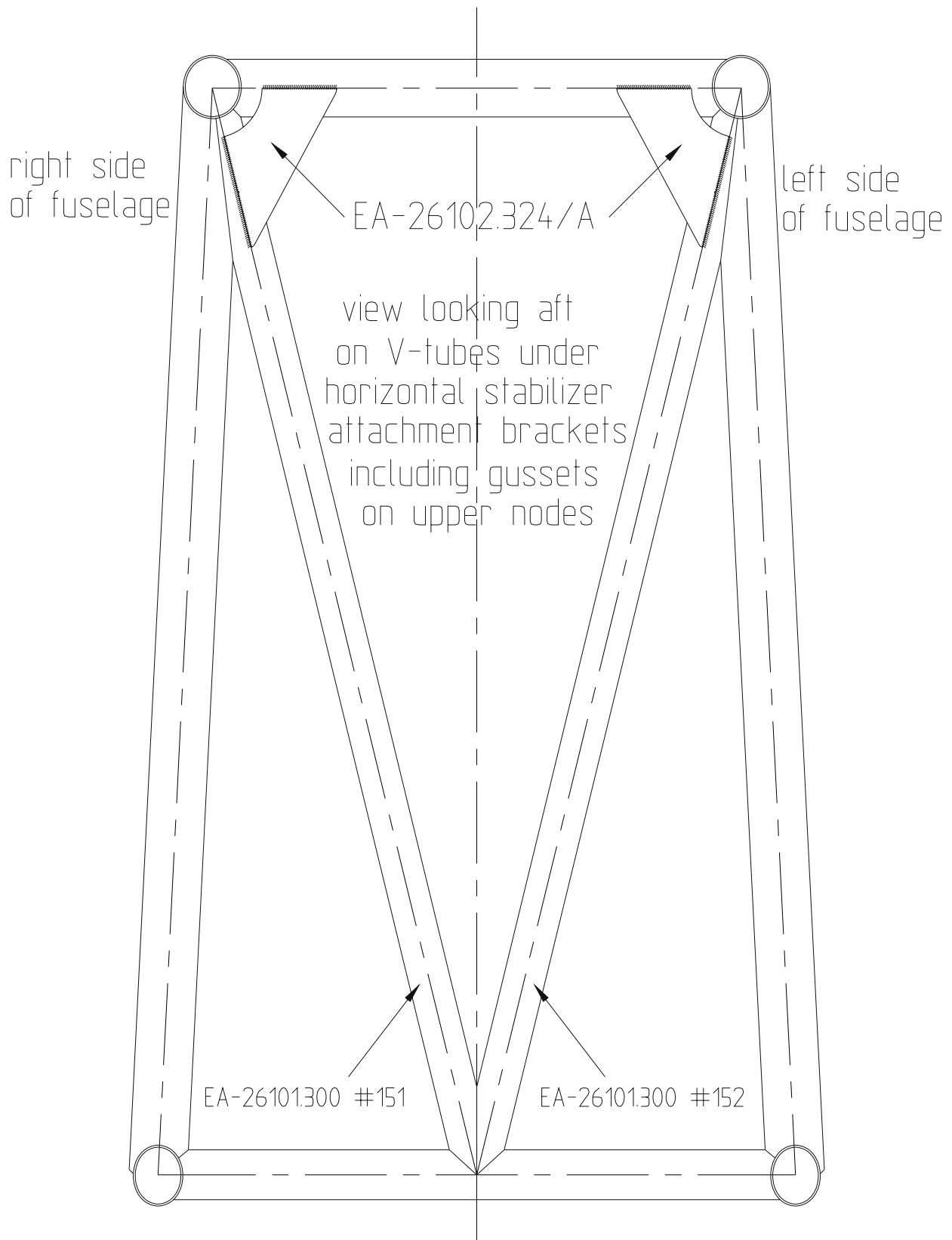

Figure 7: V-tubes and gussets for EA 300/L in 4130n (Kit No. SB295E3-2).

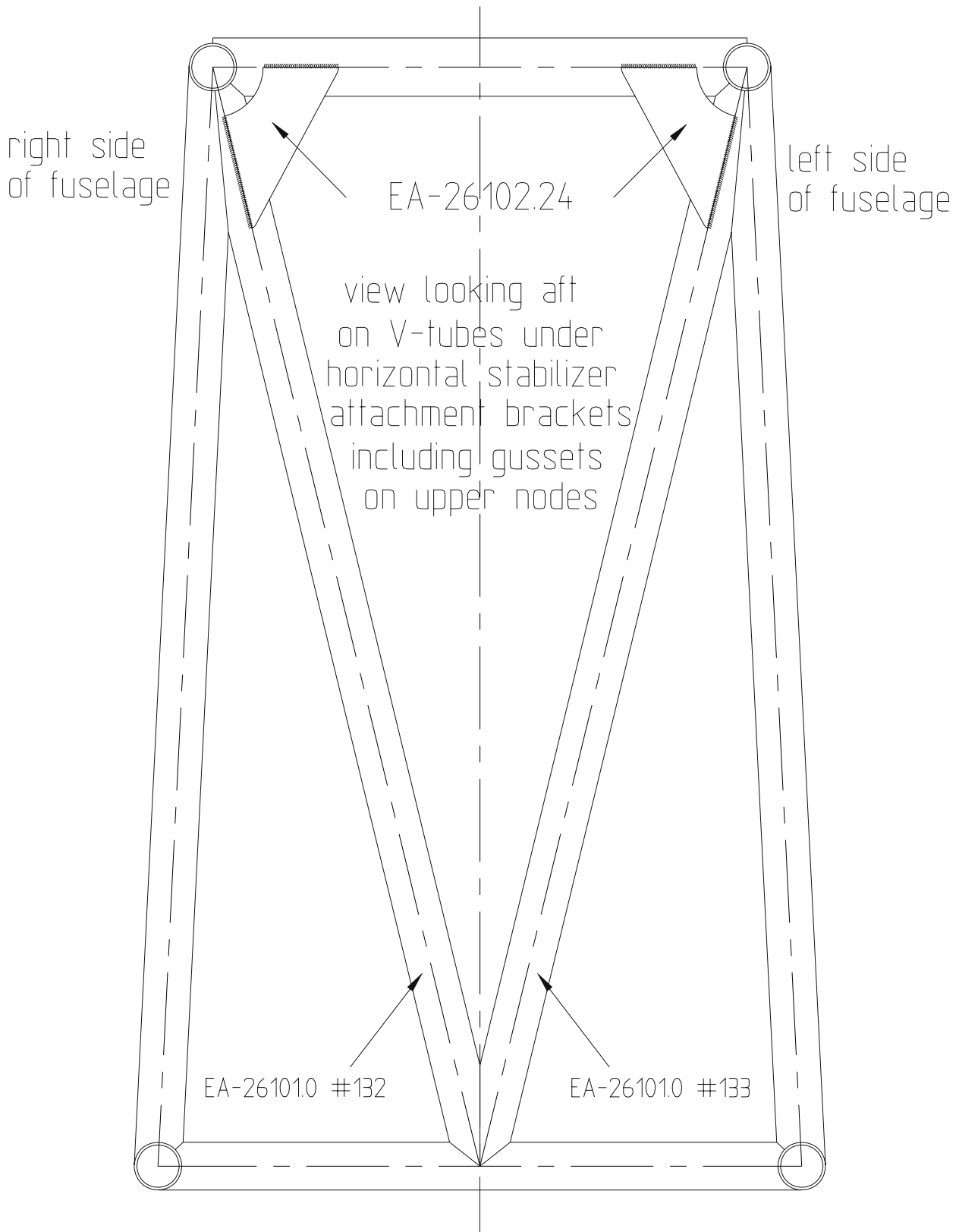

Figure 8: V-tubes and gussets for EA 300/L in 1.7734.4 (Kit No. SB295E3-3).

Appendix A:

Aircraft Type and model: EA 300 -/S -/L -/200 Serial Number:

Owner:

Registration:

Total Time:

Total landings (if known):

The aircraft mentioned above has been inspected according PART I of this Service Bulletin.

Damage has been found: Yes No

If yes, description of damage found (if possible attach supporting sketch): Note: If extend of damage is not covered by this Service Bulletin contact EXTRA Flugzeugproduktions- und Vertriebs-GmbH)

The appropriate instruction of Part I and/or Part II and/or Part III of this Service Bulletin has been carried out. (No deviation from given instructions).

Comments:

Company: _____

Aircraft inspector: _____ Date: _____

Please return a copy of this page by facsimile or airmail to:

EXTRA Flugzeugproduktions- und Vertriebs-GmbH
Engineering Department / Office of Airworthiness / Quality Assurance
Schwarze Heide 21

46569 Hünxe (Germany)

Fax. N°: (+49)-2858-9137-42

Appendix B: Overview original design

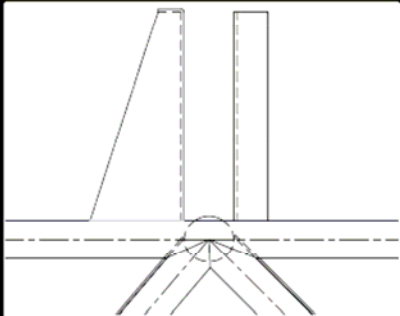
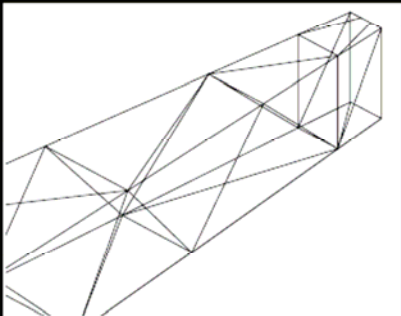
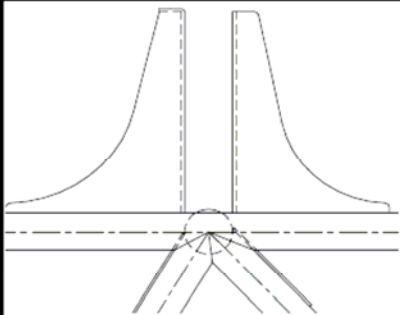
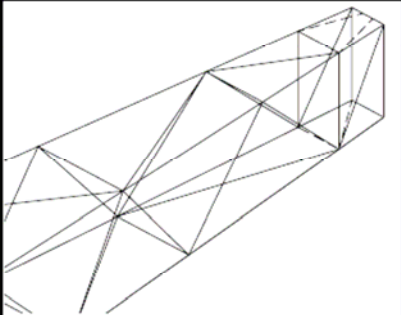
| | EA 300 | | Applies to ex-factory | |
|---|--|---|-----------------------|----------|
| | Attachment brackets | Steel tube frame | Aircraft S/N | Material |
| Initial design |  |  | 01 - 62 | 1.7734.4 |
| Changed design for improved load distribution |  |  | 63 - 67 | 1.7734.4 |

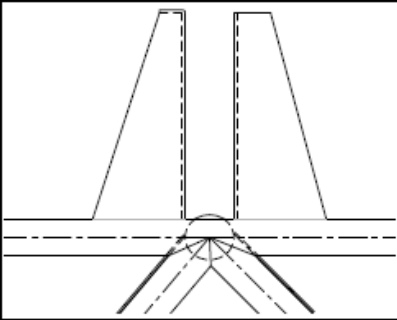
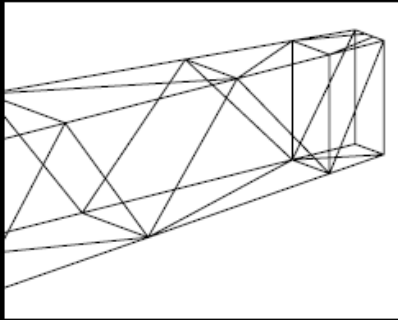
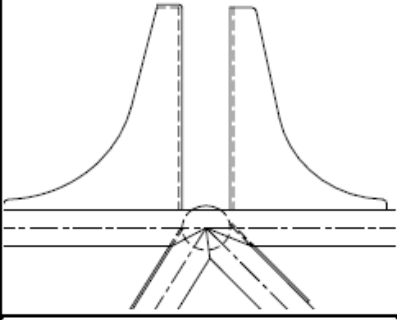
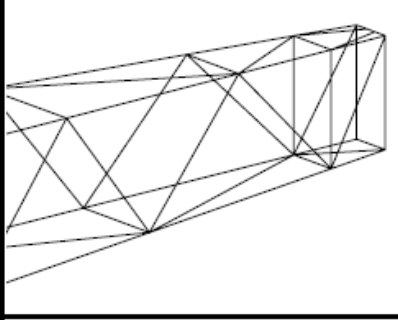
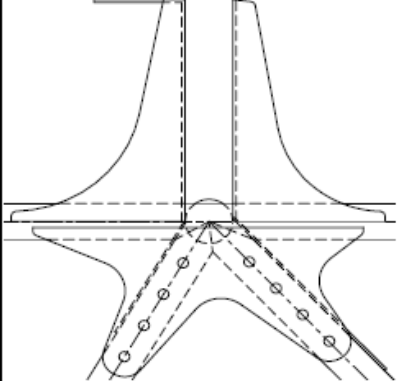
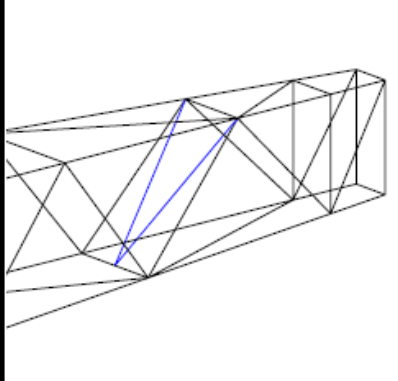
| | EA 300/S | | Applies to ex-factory | |
|---|---|--|-----------------------|----------|
| | Attachment brackets | Steel tube frame | Aircraft S/N | Material |
| Initial design |  |  | 01 - 26 | 1.7734.4 |
| Changed design for improved load distribution |  |  | 27 - 29 | 1.7734.4 |
| Changed design for compatibility with envisioned larger empennage and related higher tail loads |  |  | 30 and on | 1.7734.4 |

| | EA 300/L | | Applies to ex-factory | |
|---|---------------------|------------------|---|---|
| | Attachment brackets | Steel tube frame | Aircraft S/N | Material |
| Initial design | | | 01 - 05 | 1.7734.4 |
| Changed design for improved load distribution | | | 06 - 44 45 - 79 80 - 83 85 - 89 91 - 92 | 1.7734.4 4130n 1.7734.4 1.7734.4 1.7734.4 |
| Changed design for compatibility with envisioned larger empennage and related higher tail loads | | | 84 90 93 - and on | 1.7734.4 1.7734.4 1.7734.4 |

| | EA 300/200 | | Applies to ex-factory | |
|---|---------------------|------------------|------------------------|----------------|
| | Attachment brackets | Steel tube frame | Aircraft S/N | Material |
| Initial design | | | 01 - 31 1032 - 1039 | 4130n 4130n |
| Changed design for improved load distribution | | | 1040 and on | 4130n |